

Active Perturbation of the Near Earth Space Environment

Prof. Wayne A. Scales, PhD

Bradley Department of Electrical and Computer Engineering

Why is this an important area of research ?

- Allows study of basic physics of the near earth environment
- Allows for control of some physical processes in the space environment
- Allows for possible denial of adversary communication/navigation systems (military)
- Allows for possible new communication system techniques (military)

How is the space environment perturbed ?

- Injection of charged particle beams (heavy ions or electron beams)
- Release of chemicals that photoionize (barium)
- Release of chemicals that attach electrons (nickel carbonyl, sulfur hexafluoride, trifluoromethyl bromide)
- Release of aerosol particles (space shuttle exhaust)
- Injection of high power radio waves from space or the ground (HAARP, Arecibo, EISCAT Tromso)

What types of perturbations are produced ?

- Electron density
- Electron temperature
- Space plasma conductivity
- Natural ionospheric currents (new communication techniques !)
- Space plasma waves and turbulence (may degrade communication and navigation radio signals)

Current Projects

- Artificial Perturbation of Natural Dust Clouds in the Space Environment (Sponsored by NSF)
- Creation of Artificial Dust Clouds in the Space Environment (Sponsored by NRL)
- Creation of Artificial Plasma Clouds in Space for Remediation of Radioactive Particles after High Altitude Thermonuclear Detonation HAND (Sponsored by ONR and NRL)

Noctilucent Clouds (NLCs)



- At the Edge of Space (85 km) !
- Composed of Charged Dust (Ice) Particles
- Tracer for Upper Atmospheric Disturbances
- Associated with Unusual Radar Echoes
- Related to Global Climate Changes

Perturbation of Dust Cloud Turbulence

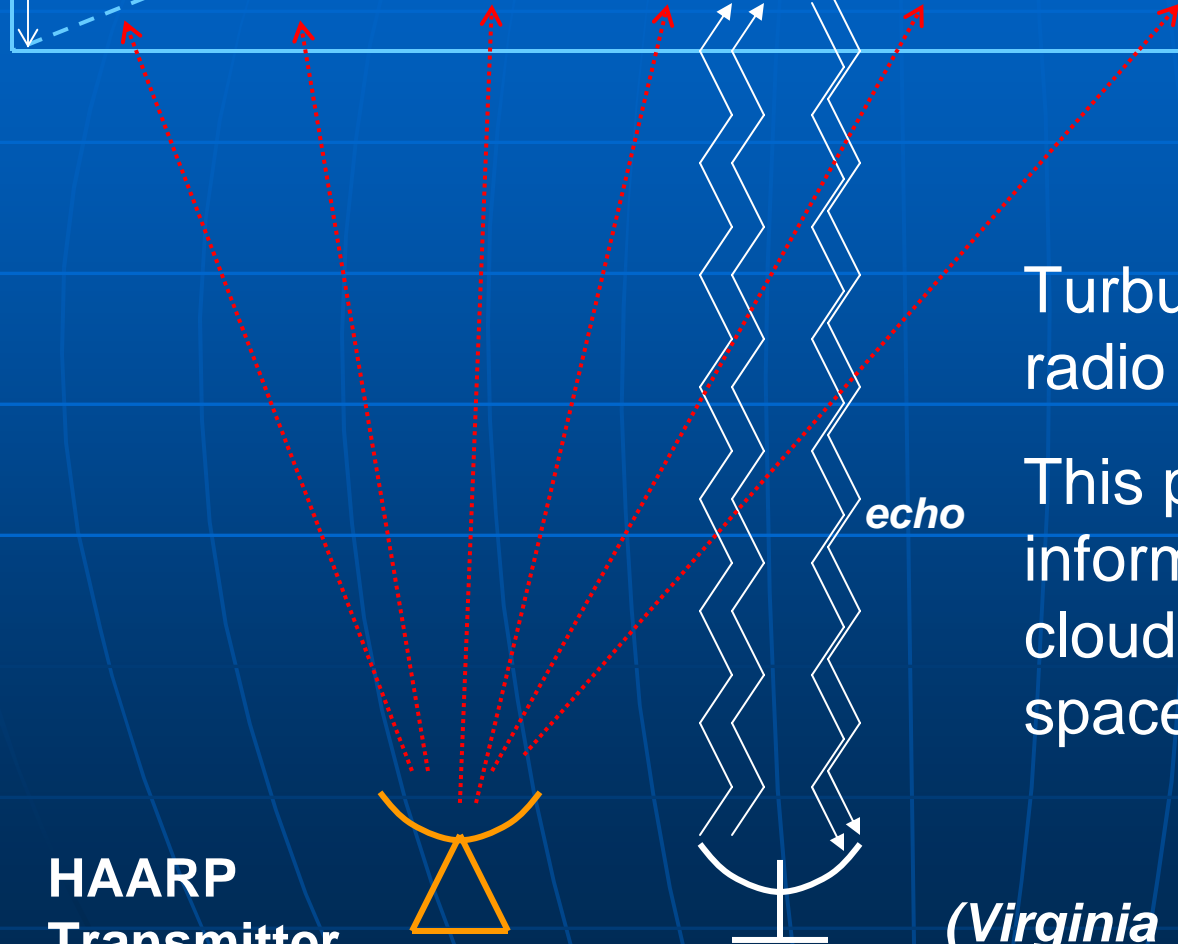
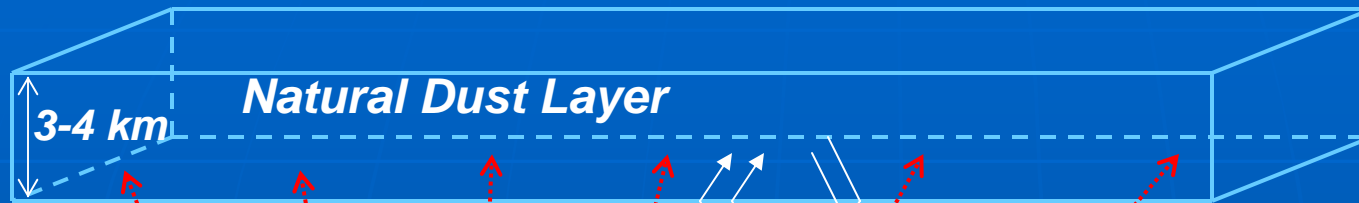

Turbulence is modified by radio wave heating

This provides diagnostic information on the dust cloud which complements space measurements

**HAARP
Transmitter**

(Virginia Tech is currently building a radar receiver for these experiments)

Facilities for Space Science measurements can be located in out of the way places !



Gakone, Alaska

Another view of HAARP

(High Frequency Active Auroral Research Program)



- 180 Antennas
- Over 30 acres !
- 3.6 MW Xmitter
- Up to 30 dB gain
- 2.8 - 10 MHz

Most power
scientific
transmitter of it's
kind in the world !

ELF/VLF
generation
research
performed here

HAARP HF Digital Receiver

HAAR HF Radar Receiver Set Up

HF Receiving Station
(Spira-Cone Antenna)



HAARP HF Transmitter
(Crossed-Dipole Antenna Array)

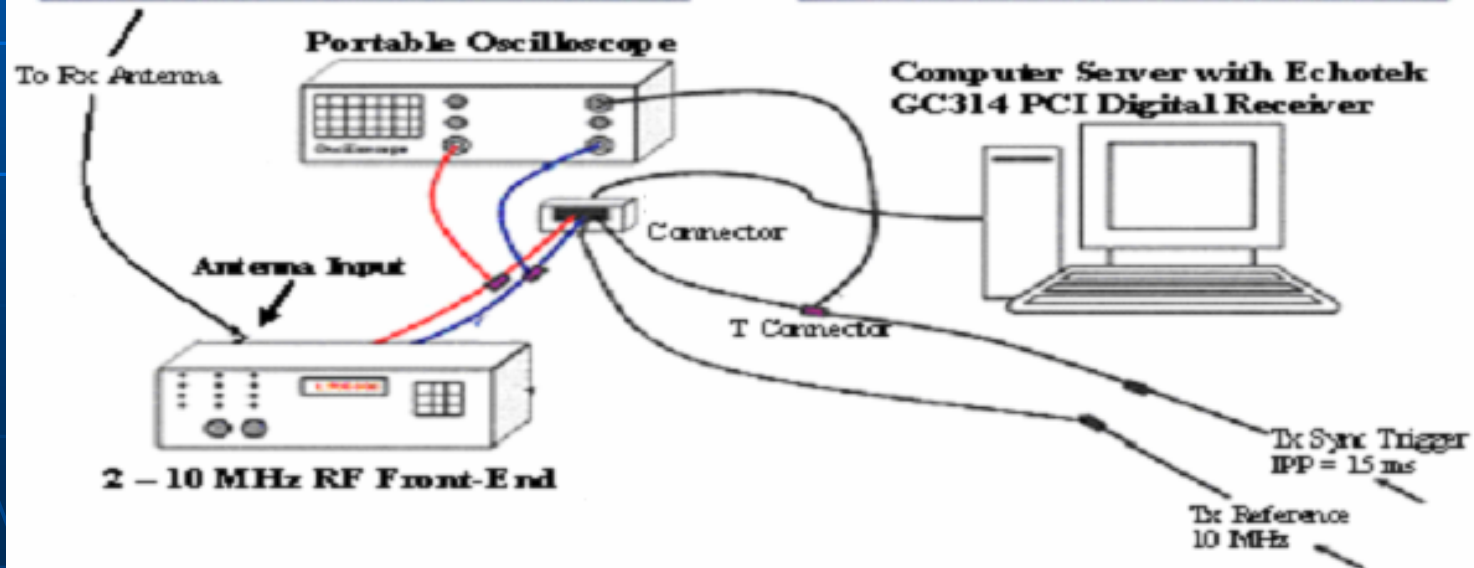

Perturbation on Dust Irregularities

t = 0 sec (initialization)

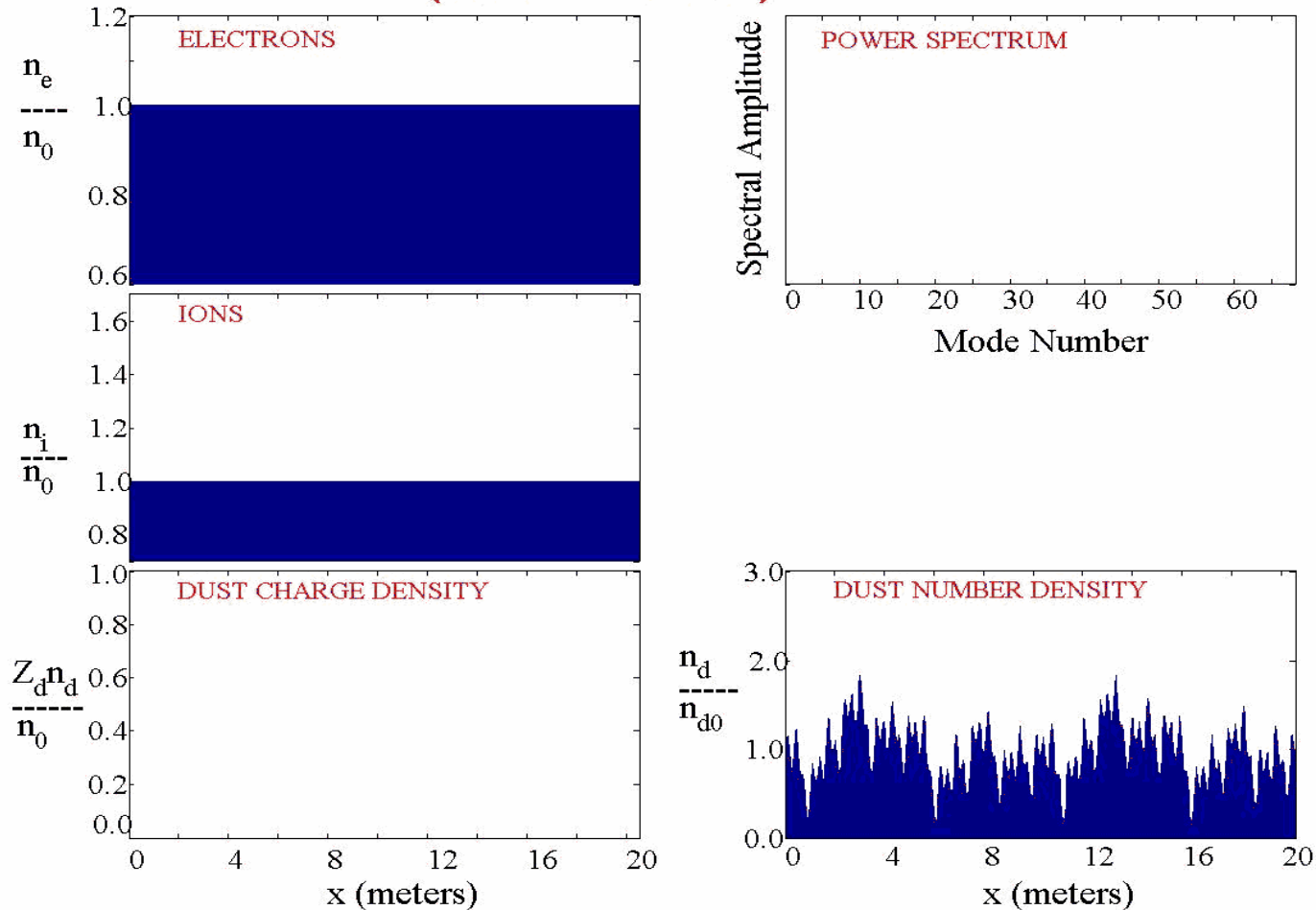

- Short-scale and long-scale turbulence behave differently to heating because of differences in the role of diffusion.

- This can be used to determine the characteristics of the dust.

Preliminary Results During Heating

(HAARP, August 2006)

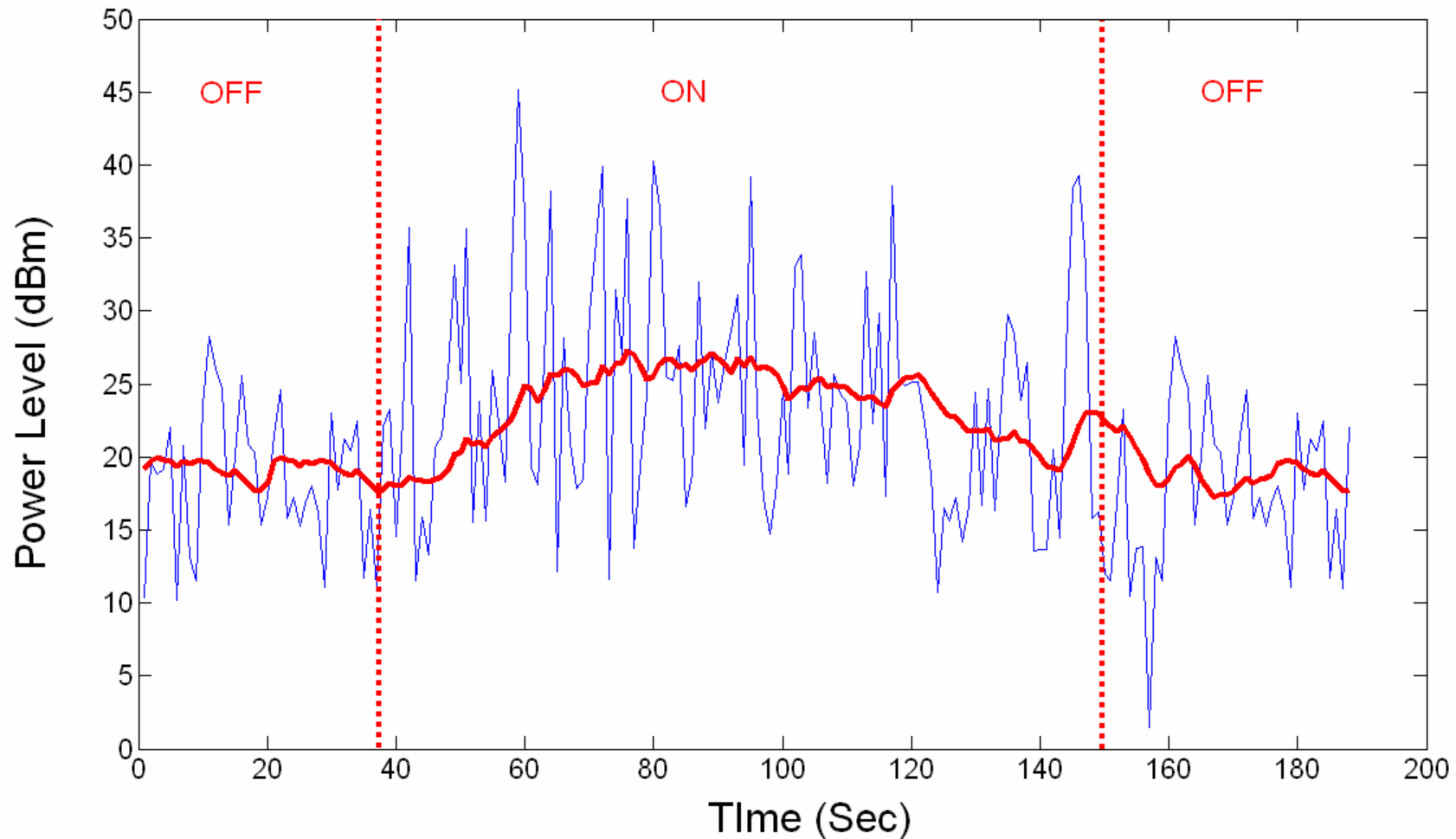

(Radar observations at 4.9 MHz indicate possible enhancement of PMSE)

Artificial Dust Layer Concept

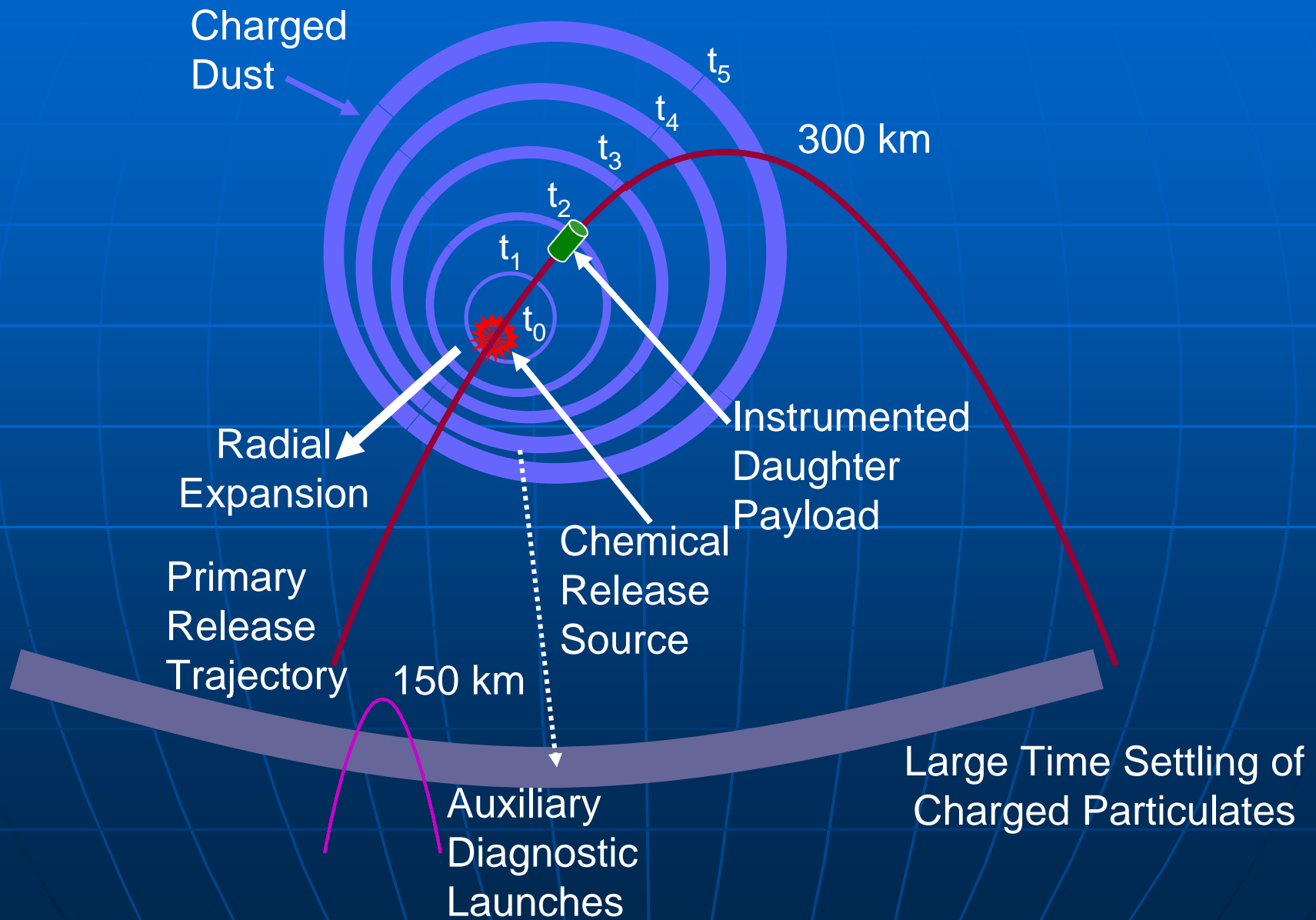

Study of Turbulence in Charged Dust Clouds

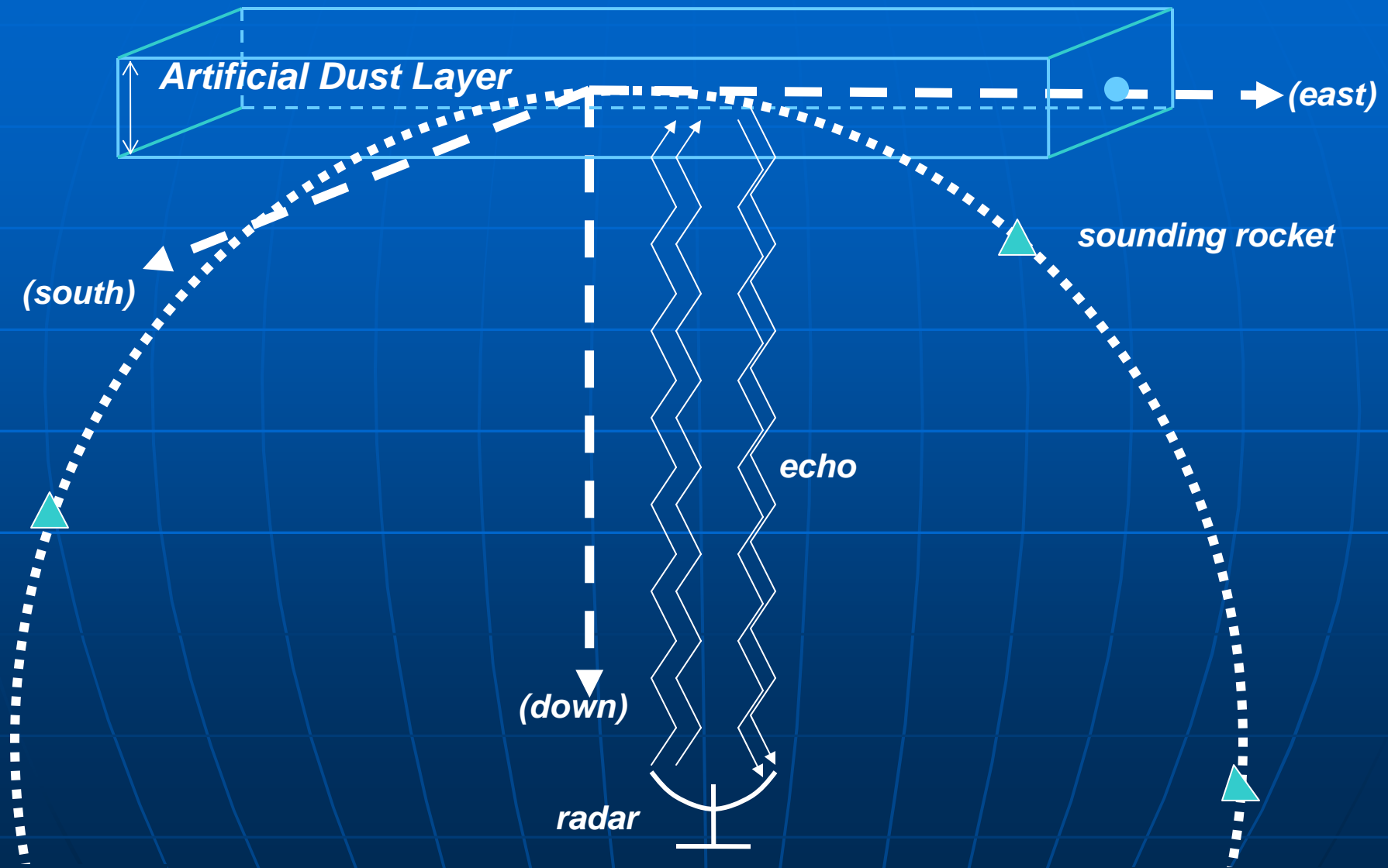

Primary CARE Rocket

(NRL Program)

- Main Rocket Structure
 - Motor (350 km Apogee)
 - Dust Release Payload (General Sciences)
 - Air Spring Separation (Wallops)
 - Attitude Control System (Wallops)
 - Instrument Payload (Wallops)
 - Radio Beacon (Bernhardt)
 - Plasma Probes
 - Plasma Resonance Probe (Swenson)
 - Langmuir Probe (TBD)
 - Charge Dust Detectors
 - Norway
 - Colorado
 - Dartmouth
 - UNH
 - Electric Fields (Cornell)
 - Neutral Dust Detector (MAGIC)
 - Photometer (UNH)
 - Nose Cone



Neutral Dust Cloud Expansion in a Non-Uniform Atmosphere

Background Atmosphere

120 km Altitude

$T = 323.3 \text{ K}$

$\rho_0 = 2.34 \cdot 10^{-8} \text{ kg/m}^3$

$H_1 = 10.2 \text{ km}$

Release Parameters

$V_s = 2 \text{ km/s}$

$v_m = 0.1 \text{ km/s}$

$V_{x0} = 0.7 \text{ km/s}$

$V_{z0} = 1.4 \text{ km/s}$

Altitude = 250 km

Al_2O_3 Particles

Density 3.97 g/cm^3

Sizes: 10^{-9} to 10^{-6} m

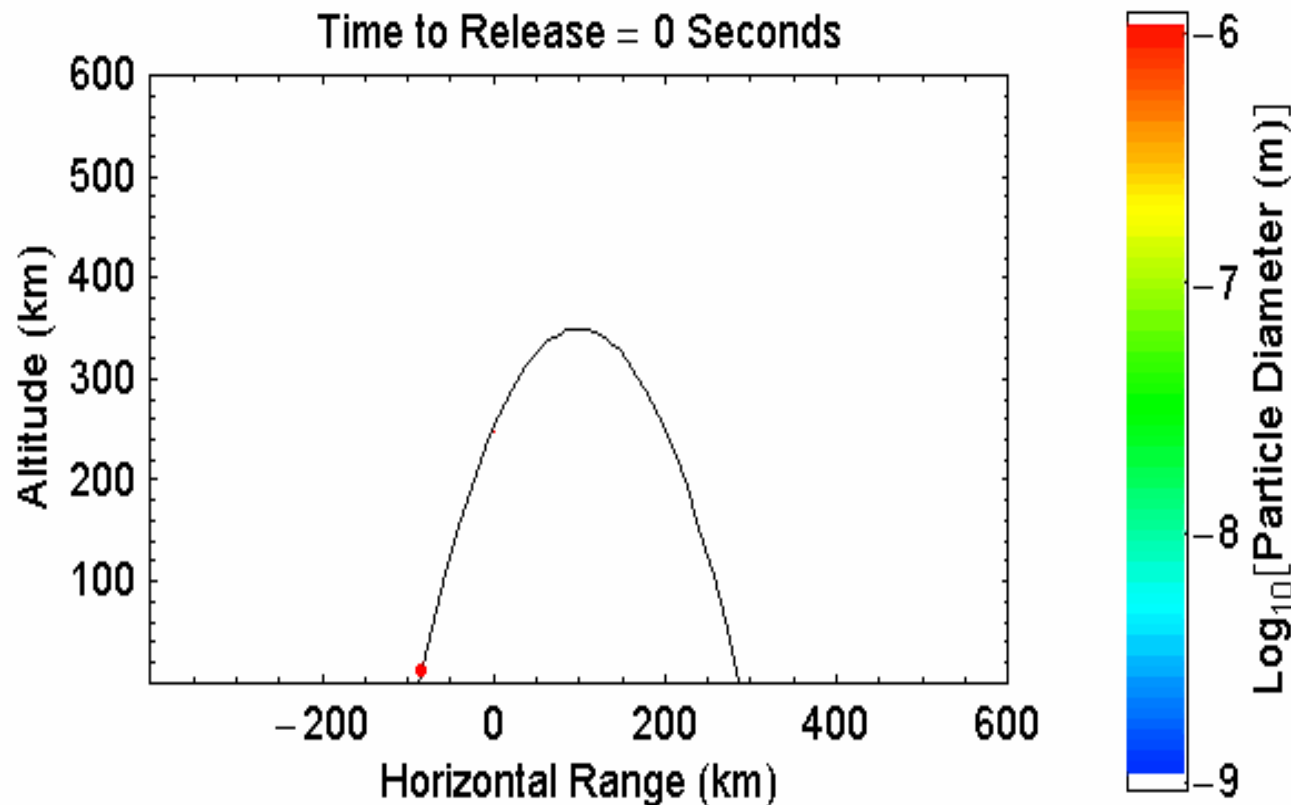

Computer Simulations of Dust Cloud Turbulence

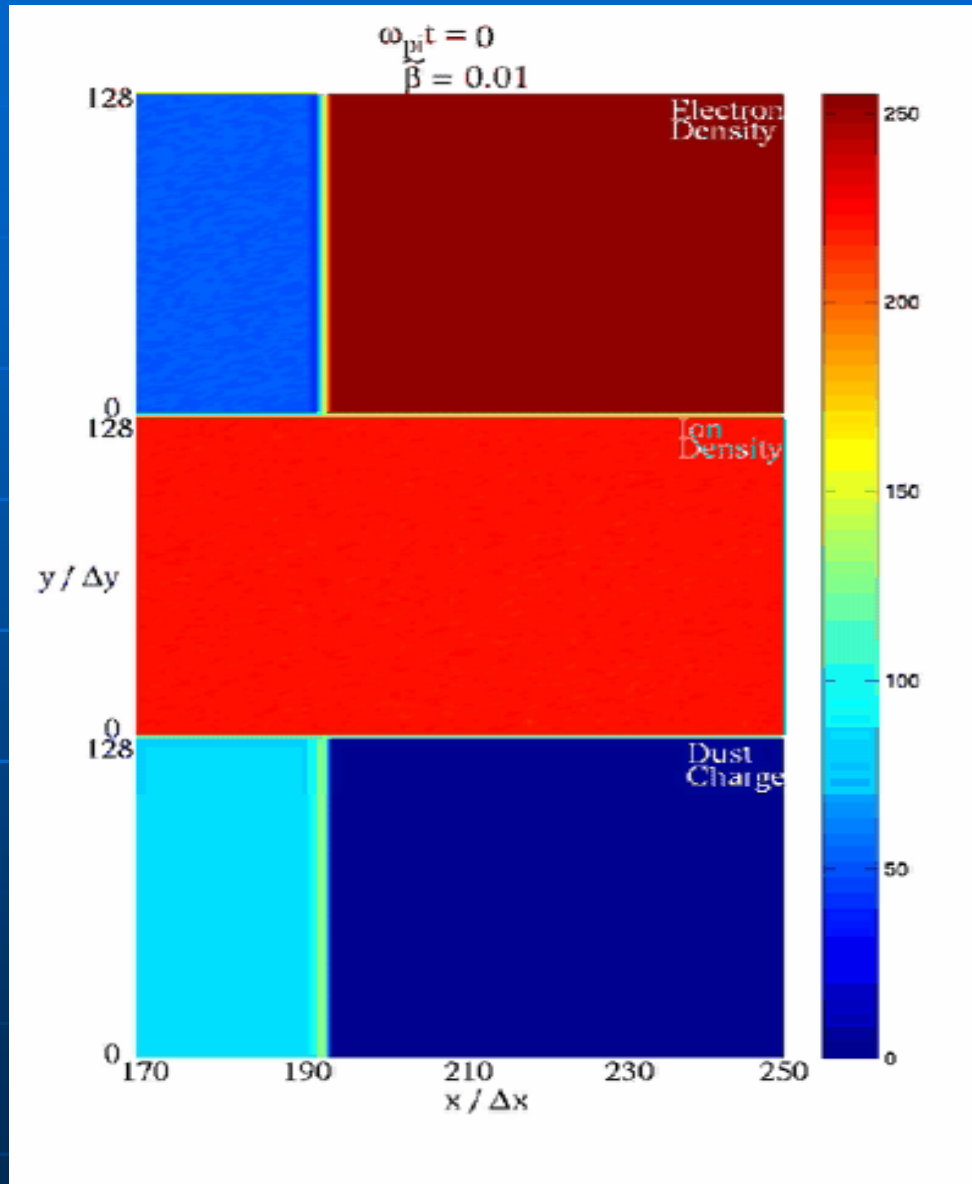

Predictions:

- Turbulence created on the edge of the dust cloud within a few milliseconds after creation
- Scale sizes of a few meters
- Effective radar scattering expected
- Turbulence due to sheared electron flows in boundary of cloud
- This should be the shortest scale turbulence produced

VT Sponsored by NSF and DOE

Radiation Belt Remediation

- New ONR sponsored MURI
- Develop techniques for pitch angle scattering of relativistic electrons from radiation belts after High Altitude Nuclear Detonation HAND
- Collaborating Universities:
 - U. Maryland (lead)
 - Stanford
 - UCLA
 - Dartmouth
 - Boston University
 - Virginia Tech

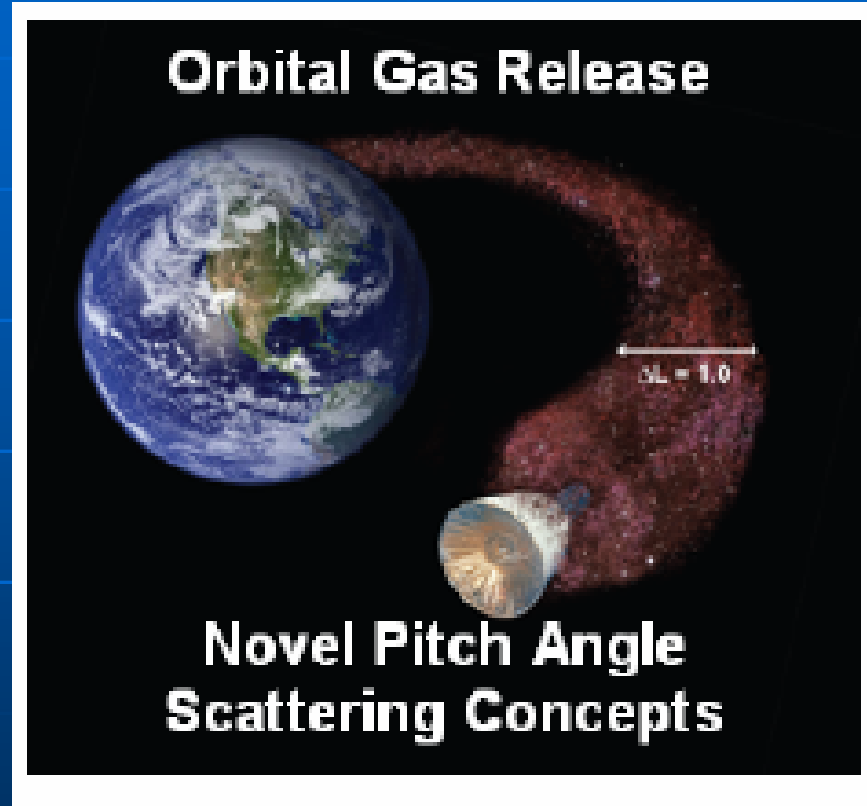

Summary

- Active perturbation of the space environment has broad applications for basic space science as well as commercial and military applications
- Currently it is an area of vigorous research
- Virginia Tech has developed significant expertise over the years in theory and modeling for a broad range of active space experiments
- Ongoing VT directions include development of experimental and hardware capabilities